



twinnno 天诺

# T6555 Online Residual Chlorine Meter Membrane Operating Manual



上海淳业仪表科技有限公司  
Shanghai Chunye Instrument Technology Co.,Ltd



# Contents

<b>Perface</b> -----	<b>1</b>
<b>Features</b> -----	<b>2</b>
<b>Specifications</b> -----	<b>3</b>
<b>Installations</b> -----	<b>4</b>
<b>wall-mounted</b> -----	<b>4</b>
<b>Instrument connection</b> -----	<b>5</b>
<b>Keypad descriptions</b> -----	<b>6</b>
<b>Display description</b> -----	<b>7</b>
<b>Menu structure</b> -----	<b>8</b>
<b>Calibration</b> -----	<b>10</b>
<b>Curve query</b> -----	<b>12</b>
<b>MODBUS RTU General Information</b> -----	<b>13</b>
<b>pH buffer and temperature values</b> -----	<b>20</b>
<b>Daily Maintance</b> -----	<b>21</b>
<b>Package set</b> -----	<b>21</b>
<b>Warranty</b> -----	<b>22</b>
<b>Notes</b> -----	<b>23</b>

# Preface

Thank you for your support. Please read this manual carefully before use. The correct use will maximize the performance and advantages of the product, and bring you a good experience.

When receiving the instrument, please open the package carefully, check whether the instrument and accessories are damaged by transportation and whether the accessories are complete. If any abnormalities are found, please contact our after-sales service department or regional customer service center, and keep the package for return processing.

This instrument is an analytical measurement and control instrument with highly precision. Only skilled, trained or authorized person should carry out installation, setup and operation of the instrument. Ensure that the power cable is physically separated from the power supply when connection or repair. Once the safety problem occurs, make sure that the power to the instrument is off and disconnected.

For example, it may insecurity when the following situations occur:

- 1) Apparent damage to the analyzer
- 2) The analyzer does not work properly or provides specified measurements.
- 3) The analyzer has been stored for a long time in an environment where the temperature exceeds 70 °C.

The analyzer must be installed by professionals in accordance with relevant local specifications, and instructions are included in the operation manual. Comply with the technical specifications and input requirements of the analyzer.

## Features

Online Free chlorine meter is a microprocessor-based water quality online monitoring control instrument. It is widely used in drinking water treatment plants, drinking water distribution networks, swimming pools, water treatment projects, sewage treatment, water disinfection and other industrial processes. It continuously monitors and controls Free chlorine and temperature value in aqueous solution.

- Color LCD display
- Intelligent menu operation
- Multiple automatic calibration function
- Manual and automatic temperature compensation
- Three relay control switches
- High & low alarm and hysteresis control
- 4-20mA & RS485, Multiple output modes
- Multi parameter display simultaneously shows –Free Chlorine, Temp, current, etc.
- Password protection function to prevent misoperation by non-staff.

## Technical Specification

Measurement range	0.005~20.00mg/L ; 0.005~20.00ppm
Measurement unit	Membrane
Resolution	0.001mg/L ; 0.001ppm
Basic error	±1%F.S
Measurement range	-2~16.00pH
Measurement unit	pH
Resolution	0.001pH
Basic error	±0.01pH
Temperature	-10~150.0°C( Based on sensor)
Temperature Resolution	0.1°C
Temperature Basic error	±0.3°C
Current output	2 groups: 4~20mA
Signal output	RS485 Modbus RTU
Other functions	Data record &Curve display
Three relay control contacts	3 groups:5A 250VAC,5A 30VDC
Optional power supply	85~265VAC,9~36VDC,power consumption≤3W
Working conditions	No strong magnetic field interference around except the geomagnetic field.
Working temperature	-10~60°C
Relative humidity	≤90%
Waterproof rating	IP65
Weight	1.5kg
Dimensions	235×185×120mm
Installation methods	Wall mounted

# Installations

Installation size

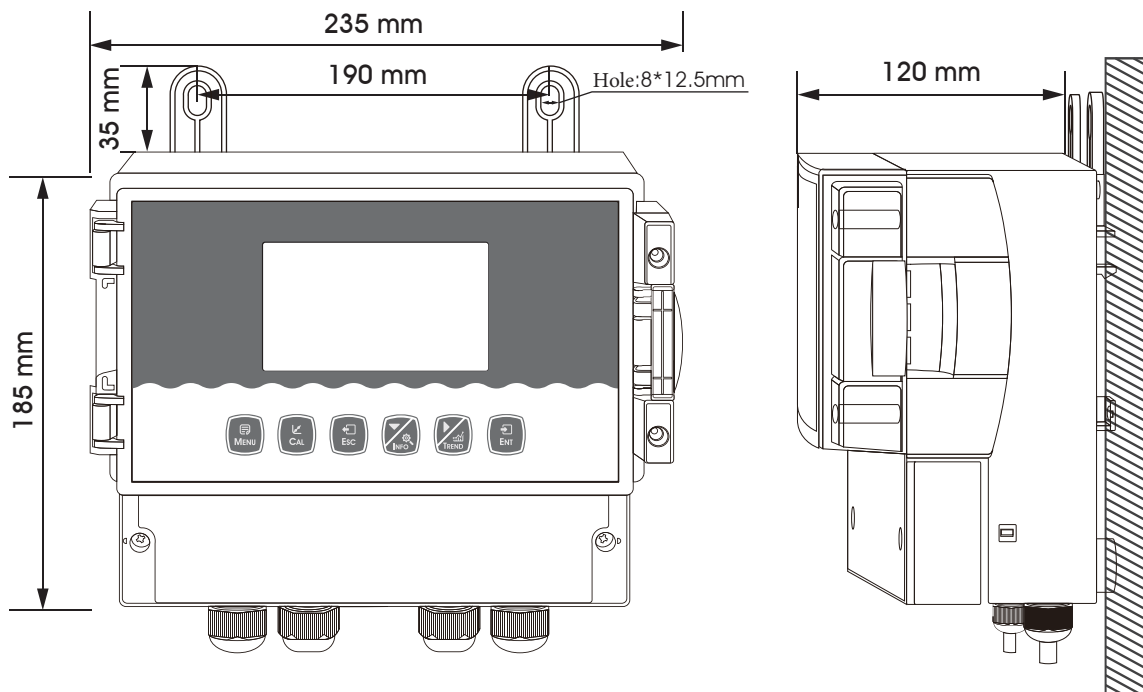

Instrument shape, wall - mounted fixed piece size

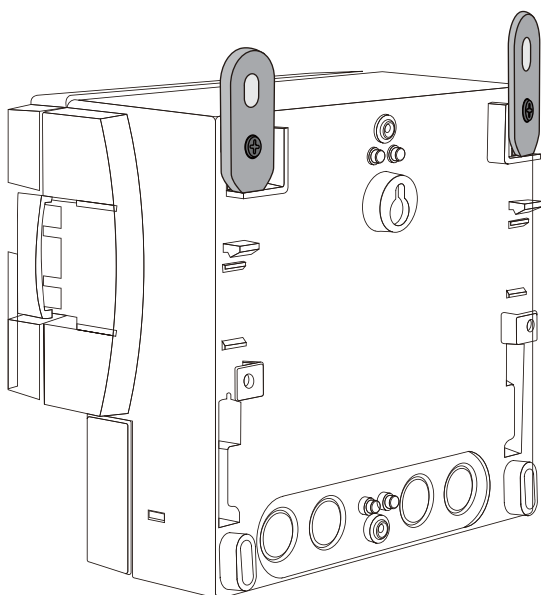

Fix the fixed piece of the instrument

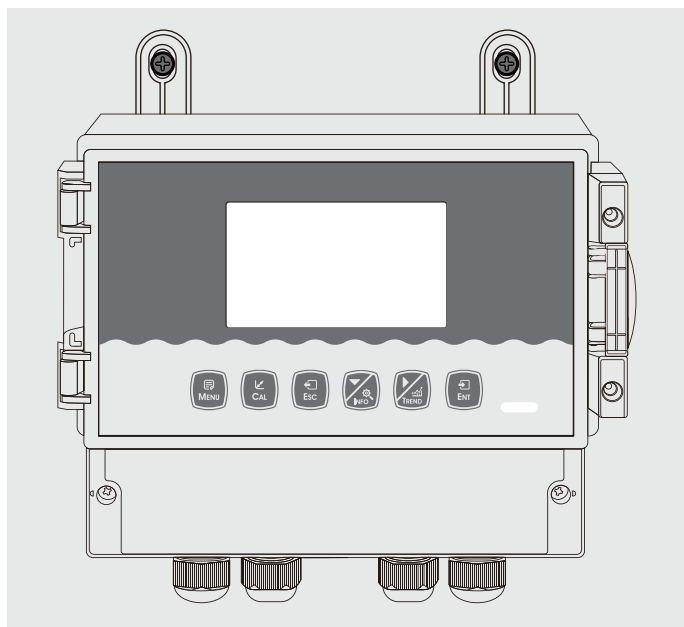

Installation completion drawing

## Instrument connection

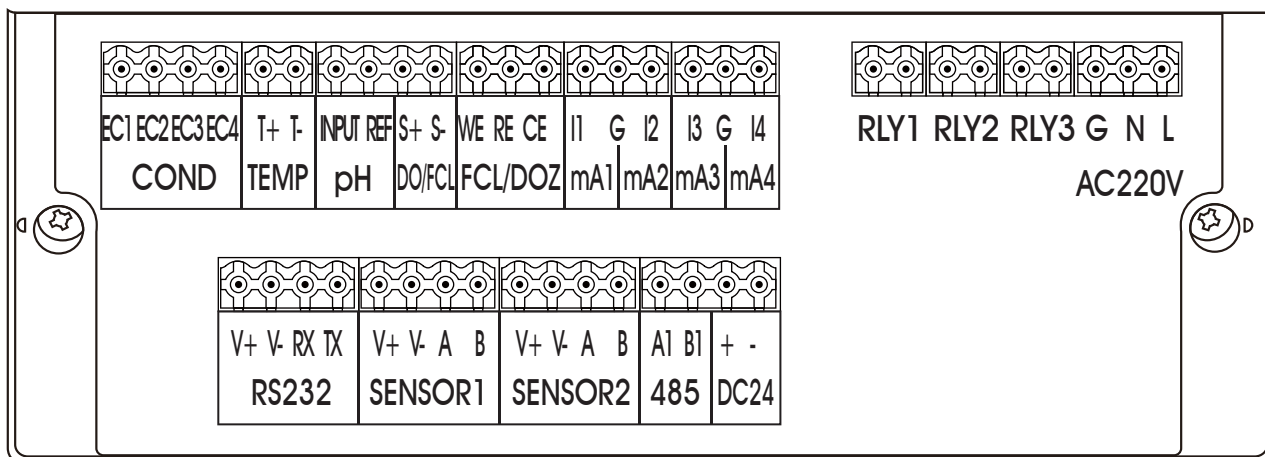

<b>EC1, EC2, EC3, EC4</b>	Electrical conductivity/resistivity wiring	<b>RLY1 RLY2 RLY3</b>	3 groups of relay
<b>T+, T-</b>	Temperature connection	<b>G, L, N</b>	G-ground wire, L-live, N-neutral
<b>INPUT</b>	<b>pH/ORP/Ion measure</b>		
<b>REF</b>	<b>pH/ORP/Ion reference</b>	<b>V+, V-, RX, TX</b>	RS232 communication output
<b>S+, S-</b>	Membrane dissolved oxygen, FCL	<b>V+, V-, A, B</b>	Digital input channel 1
<b>CE, RE, WE</b>	Constant voltage residual chlorine/ chlorine dioxide/ozone	<b>V+, V-, A, B</b>	Digital input channel 2
<b>I1, G, I2</b>	Output current	<b>A1, B1</b>	RS485 communication output
<b>I3, G, I4</b>	Input current	<b>+, -</b>	DC power supply

The connection between the instrument and the sensor: the power supply, output signal, relay alarm contact and the connection between the sensor and the instrument are all inside the instrument, and the wiring is as shown above. The length of the cable lead fixed by the electrode is usually 5-10 Meters, insert the corresponding label or color wire on the sensor into the corresponding terminal inside the instrument and tighten it.

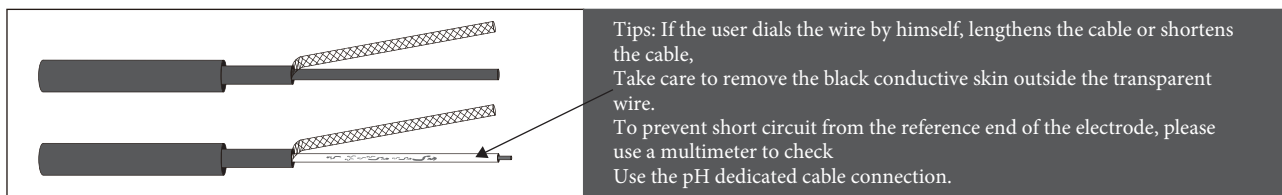



# Keypad descriptions

Keypad operation tips:

Short Press: Short Press means to release the key immediately after pressing. ((Default to short presses if not indicated below)

Long Press: Long Press is to press the button for 3 seconds and then release it.

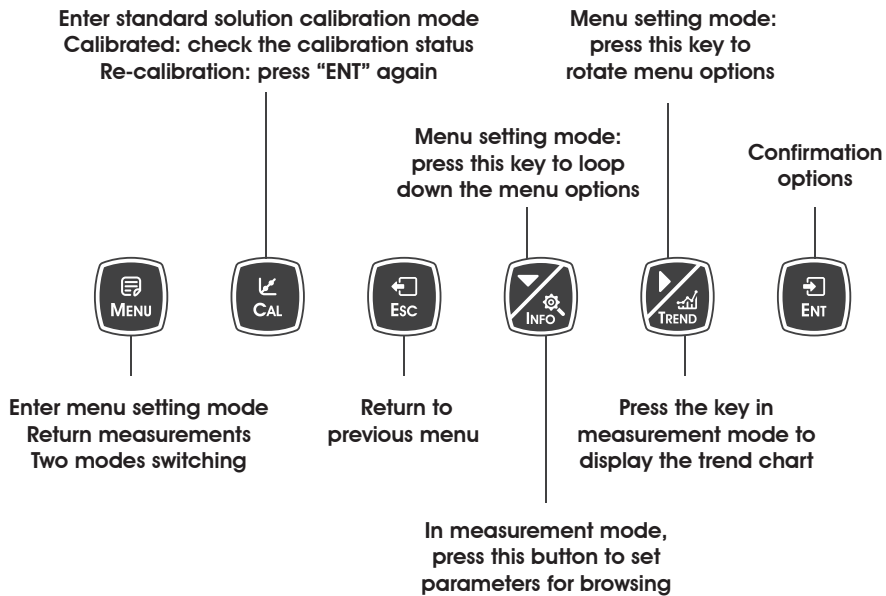

# Display descriptions

All pipe connections and electrical connections should be checked before use. After the power is switched on, the meter will display as follows.

The main display screen shows the following information:

- Year-Month-Date Time:** 2019-01-09 12:53:17
- Main measurement+ Unit:** 8.025 mg/L
- Sensor Communication Warning:** Indicated by a yellow warning triangle icon.
- pH Compensation +Unit:** 7.01 pH
- Temp. + Unit Automatic temp. comp.:** ATC 25.0 °C
- Relay 1 [blue is off and red is on]:** SP1 (off), SP2 (on), SP3 (off)
- Relay 2 [blue is off and red is on]:** SP4 (off), SP5 (on)
- Relay 3 [blue is off and red is on]:** SP6 (off), SP7 (on)
- Instrument type:** Free Chlorine
- Current 1 Current 2 Switch display:** 14.51 mA
- Cleaning:** Indicated by a cleaning icon.

## Measurement Mode

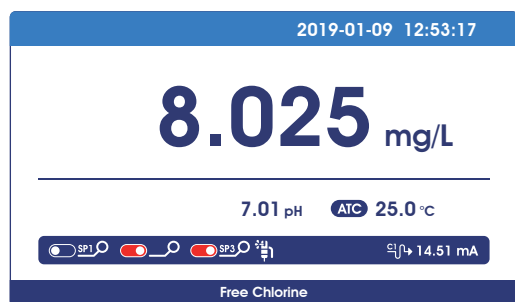

## Setting mode



## Calibration Mode



## Trend Chart Display

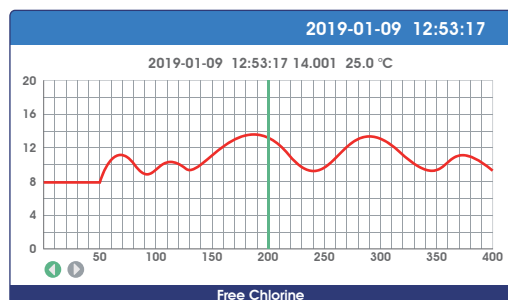

# Menu structure

The following is the menu structure of this instrument, press **[MENU]** key to enter menu setting mode:

If the monitor prompts you to enter the calibration security password, press the **[▼]** key or **[▶]** key to set the calibration security password, and then press the **[ENT]** key to confirm the calibration security password. No initial password here, please enter directly by press **[ENT]** key.

Configure	Sensor	Type	FCL		
		Unit	mg/L		
	Temp.	Temperature Sensor	NTC2.252 kΩ		
			NTC10 kΩ		
			Pt100		
			Pt1000		
		Temperature Offset	0.0000		
		Temperature Input	Automatic	Manual	
	Temperature Unit	°C	°F		
	Calibration	Standard Solution Calibration	Calibration Point 1	0.01 (Default, can be modified)	
Calibration Point 2			1 (Default, can be modified)		
Calibration Point 3			10 (Default, can be modified)		
Calibration Point 4			100 (Default, can be modified)		
Calibration Point 5			1000 (Default, can be modified)		
Correction			Voltage 1	Voltage 2	
		Voltage 3A	Voltage 3B		
		Voltage 4A	Voltage 4B		
		Voltage 5			
Field Calibration		Field Calibration			
		Offset Adjustment			
		Slope Adjustment			
Alarm		Relay 1	Status	ON	OFF
				High/Low Alarm	High Alarm
			Cleanning(Cleaning time setting is as below)		
	Limit Value (Cycle) -under cleaning status		(Continuous opening time)		
	Hysteresis (INterval) -under cleanning status		(The interval between the last opening and closing and the next opening)		
	Relay 2		Status	ON	OFF
		High/Low Alarm		High Alarm	Low Alarm
			Cleanning(Cleaning time setting is as below)		
		Limit Value (Cycle) -under cleaning status	(Continuous opening time)		
		Hysteresis (INterval) -under cleanning status	(The interval between the last opening and closing and the next opening)		
		Relay 3	Status	ON	OFF
	High/Low Alarm			High Alarm	Low Alarm
			Cleanning(Cleaning time setting is as below)		
	Limit Value (Cycle) -under cleaning status		(Continuous opening time)		
	Hysteresis (INterval) -under cleanning status		(The interval between the last opening and closing and the next opening)		

Output	Current 1	Channel	Main
		Output Option	Temperature
			4-20mA
			0-20mA
			20-4mA
		Upper Limit	
		Lower Limit	
	Current 2	Channel	Main
		Output Option	Temperature
			4-20mA
			0-20mA
			20-4mA
		Upper Limit	
		Lower Limit	
	RS485	Baud Rate	4800BPS
9600BPS			
19200BPS			
Parity Check		None	
		Odd	
		Even	
Stop Bit		1 Bit	
	2 Bit		
Network Node	001 +		
Data Log	Graphic Trend (trend chart)	Interval/point	
		1h/point	
		12h/point	
		24h/point	
	Data Query Interval	year/month/day	
		7.5s	
		90s	
		180s	
	Data Output		
	Memory information	176932point	
System	Language	Chinese	
		English	
	Date/Time	Year-Month-Day	
		Hour-Minute-Second	
	Display	Display Speed	Low
			Standard
			Medium
			High
	Backlight	Saving	
		Bright	
	Soft Version	Soft Version	19-1.0
		Password Settings	0000
		Serial Number	
	Factory Default	No	
		Yes	
Terminal Current Tuning	Current 1 4mA	(The positive and negative ends of the ammeter are connected to the current 1 or current 2 output terminals of the instrument respectively, press <b>【▼】</b> key to adjust the current to 4 mA or 20mA ,press <b>【ENT】</b> key to confirm.)	
	Current 1 20mA		
	Current 2 4mA		
	Current 2 20mA		
Relay Test	Relay 1	(Select three groups of relays and hear the sound of two switches, the relay is normal.)	
	Relay 2		
	Relay 3		

# Calibration

Press [MENU] to enter the setting mode and select the calibration

Calibration	Standard Solution Calibration	Calibration Point 1	0.01 (Default, can be modified)
		Calibration Point 2	2 (Default, can be modified)
		Calibration Point 3	5 (Default, can be modified)
		Calibration Point 4	10 (Default, can be modified)
		Calibration Point 5	20 (Default, can be modified)
Field Calibration	Field Calibration		
	Offset Adjustment		
	Slope Adjustment		

## Standard Solution Calibration

This function is used to calibrate the five calibration points of the sensor. It has been calibrated before delivery and users can use it directly.

If calibration is required, prepare 5 suitable standard liquids with known range, press the [MENU] key to enter the setting mode and select the calibration point.

Modify or enter the corresponding calibration value. After setting the calibration value, press [ENT] key to confirm and enter the calibration screen.

(If the instrument has been calibrated, the screen shows the calibration status. press the [▶] key to switch the calibration state of the calibration point. If you need re-calibration, in this state, press the [ENT] key again to enter the re-calibration.)

Standard solution calibration total has five calibration points, you can choose any one point to calibration (At least, choose one point to calibration).

In the standard solution calibration mode, press the [▶] key to switch the calibration points, press the [ENT] key to start calibrating.

If the monitor prompts you to enter the calibration security password, press the [▼] key or [▶] key to set the calibration security password, and then press the [ENT] key to confirm the calibration security password.

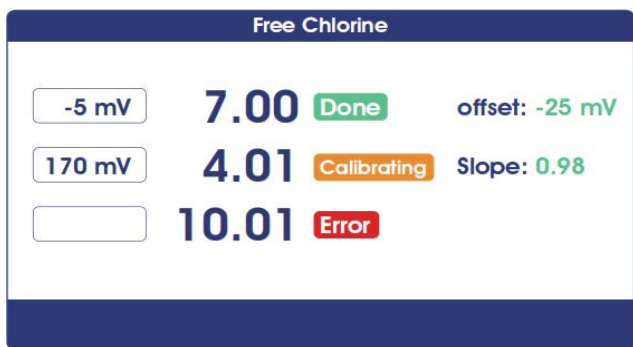
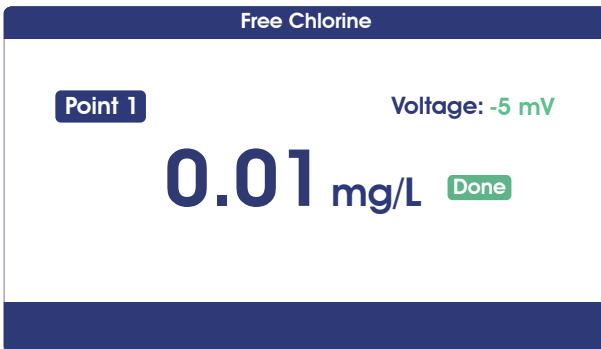

**Calibration point 1:** Calibration point 1: After entering the calibration mode, the instrument displays as shown above.

The instrument main measurement value displays the point 1 known standard solution value.

Place the electrode into the standard solution of the corresponding value, and the corresponding voltage mV value and calibration state will be displayed on the left side of the screen.

After completion of calibration, "Done" will be displayed on the right side of the screen.

If you want to calibrate the next point, press the [▶] key to switch the calibration point.

If only one point calibration is required, press the [MENU] key to return to the superior Menu after calibration.

During the calibration process, the calibration status will be displayed on the right side of the screen. "Done" indicates successful calibration, "Calibrating" indicates in calibration, and "Error" indicates failure.

## Field Calibration

Select on-site calibration methods: [Linear calibration], [Offset adjustment], [linear adjustment].

## Field Calibration

When the data from laboratory or portable instrument are input into this item, the instrument will automatically correct the data.



Free Chlorine

↙

mg/L: 07.00      Slope: 00.984

Vol: -002

Temp: 25.0 °C

Calibrating      Done

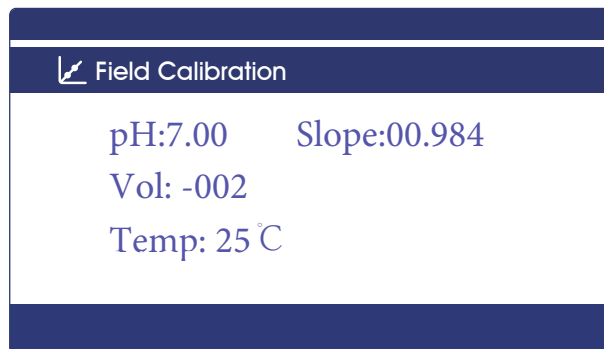

↙ Field Calibration

pH:7.00      Slope:00.984

Vol: -002

Temp: 25 °C

## Calibration results:

Confirm: When the "ENT" icon is green, press **[ENT]** to confirm.

Cancel: Press the **[▶]** key to shift the green icon to ESC, and press **[ENT]** key to confirm.

## Offset adjustment

Compare the data of laboratory or portable instrument with the data of instrument measurement, if there are errors, the error data can be modified by this function.

## Linear adjustment

Linear values after "field calibration" are stored in this item, with factory data of 1.00.

# Graphic Trend(Trend Chart)

Press **[Menu]** key to enter the setting mode, set the recording interval, and the instrument will

Data Log	Curve query (trend chart)	Interval/point	400 points per screen, displays the most recent data trend graph according to interval Settings
		1h/point	400 points per screen, display trend chart of the last 16 days of data
		12h/point	400 points per screen, display trend chart of the last 200 days of data
		24h/point	400 points per screen, display trend chart of the last 400 days of data
	Data Query	year/month/day	Year/month/day time: minute: second value unit
	Interval	7.5s	Store data every 7.5 seconds
		90s	Store data every 90 seconds
180s		Store data every 180 seconds	

Press the **[MENU]** button returns to the measurement screen. Press the **[▶/TREND]** button in the measurement mode to view the trend chart of the saved data directly. There are 480 sets of data record per screen, and the interval time of each record can be selected [7.5s, 90s, 180s], corresponding to the data displayed in [1h, 12h, 24h] per screen.

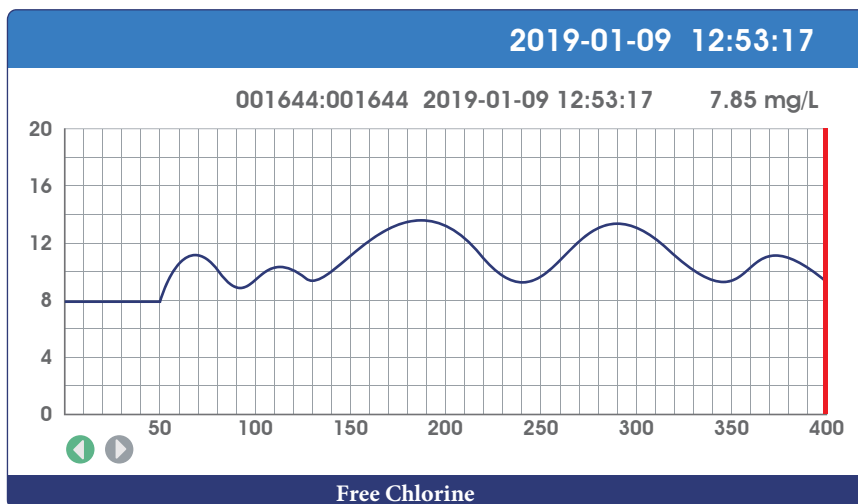

In the current mode, press the **[ENT]** key to move the data display line to the left and right (Red), and display the data in left and right circles. Long pressing of the **[ENT]** key can accelerates displacement. (When the bottom icon  is green, **[ENT]** key is displacement direction, press **[▶/TREND]** key to switch the direction of displacement )

# MODBUS RTU General Information

## Overview

The hardware version number of this document is V2.0; the software version number is V5.9 and above. This document describes the MODBUS RTU interface in details and the target object is a software programmer.

## MODBUS command structure

Data format description in this document;  
Binary display, suffix B, for example: 10001B  
- decimal display, without any prefix or suffix, for example: 256  
Hexadecimal display, prefix 0x, for example: 0x2A  
ASCII character or ASCII string display, for example: "YL0114010022"

### Command Structure

The MODBUS application protocol defines the Simple Protocol Data Unit (PDU), which is independent of the underlying communication layer.



Figure 1: MODBUS Protocol Data Unit

MODBUS protocol mapping on a specific bus or network introduces additional fields of protocol data units. The client that initiates the MODBUS exchange creates the MODBUS PDU, and then adds the domain to establish the correct communication PDU.

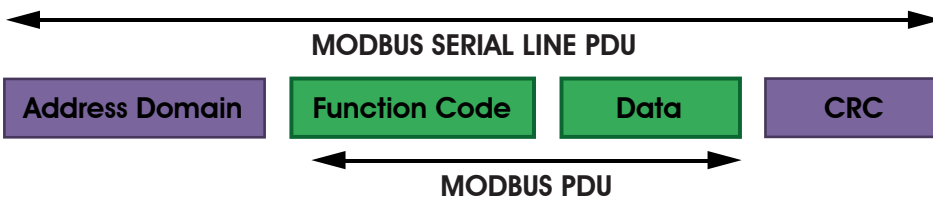

Figure 2: MODBUS architecture for serial communication

On the MODBUS serial line, the address domain contains only the slave instrument address. Tips: The device address range is 1...247

Set the device address of the slave in the address field of the request frame sent by the host.

When the slave instrument responds, it places its instrument address in the address area of the response frame so that the master station knows which slave is responding.

Function codes indicate the type of operation performed by the server.

CRC domain is the result of the "redundancy check" calculation, which is executed according to the information content.



## MODBUS RTU Transmission Mode

When the instrument uses RTU (Remote Terminal Unit) mode for MODBUS serial communication, each 8-bit byte of information contains two 4-bit hexadecimal characters. The main advantages of this mode are greater character density and better data throughput than the ASCII mode with the same baud rate. Each message must be transmitted as a continuous string.

The format of each byte in RTU mode (11 bits):

Coding system: 8-bit binary

Each 8-bit byte in a message contains two 4-bit hexadecimal characters (0-9, A-F)

Bits in each byte: 1 starting bit

8 data bits, the first minimum valid bits without parity check bits

2 stop bits

Baud rate: 9600 BPS

How characters are transmitted serially:

Each character or byte is sent in this order (from left to right) the least significant bit (LSB)... Maximum Significant Bit (MSB)

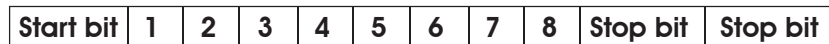

**Figure 3: RTU pattern bit sequence**

**Check Domain Structure:** Cyclic Redundancy Check (CRC16)

**Structure description:**

Slave Instrument	Function Code	Data	CRC	
Address	1 byte	0...252 byte	2 byte	
			CRC Low byte	CRCHigh byte

**Figure 4: RTU information structure**

The maximum frame size of MODBUS is 256 bytes

MODBUS RTU Information Frame

In RTU mode, message frames are distinguished by idle intervals of at least 3.5 character times, which are called t<sub>3.5</sub> in subsequent sections.

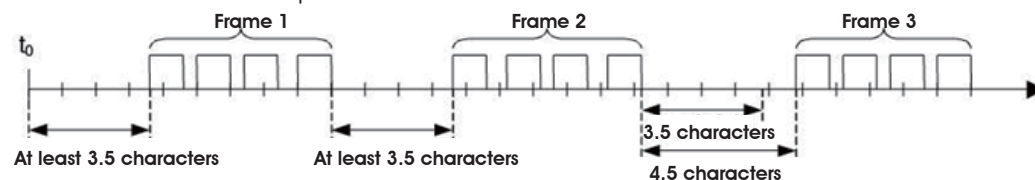

Starting	Address	Function code	Data	CRC check	End
≥ 3.5 characters	8 bit	8 bit	Nx8 bit	16 bit	≥ 3.5 characters

**Figure 5: RTU message frame**

The entire message frame must be sent in a continuous character stream.

When the pause time interval between two characters exceeds 1.5 characters, the information frame is considered incomplete and the receiver does not receive the information frame.

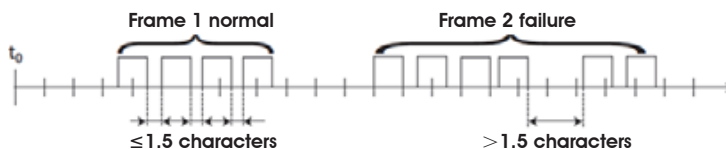

### MODBUS RTU CRC Check

The RTU mode contains an error-detection domain based on a cyclic redundancy check (CRC) algorithm that performs on all message contents. The CRC domain checks the contents of the entire message and performs this check regardless of whether the message has a random parity check. The CRC domain contains a 16-bit value consisting of two 8-bit bytes. CRC16 check is adopted. Low bytes precede, high bytes precede.

# Implementation of MODBUS RTU in Instrument

According to the official MODBUS definition, the command starts with a 3.5 character interval triggering command, and the end of the command is also represented by a 3.5 character interval. The device address and MODBUS function code have 8 bits. The data string contains n\*8 bits, and the data string contains the starting address of the register and the number of read/write registers. CRC check is 16 bits.

Value	Start	Device address	Function	Data	Summary Check		End
	No signal bytes during 3.5 characters	1-247 1	Function codes conforming to MODBUS specification	Data conforming to MODBUS specification	CRCL	CRCL	No signal bytes during 3.5 characters
Byte	3.5		1	n	1	1	3.5

**Figure 7: MODBUS definition of data transmission**

Instrument MODBUS RTU function code

The instrument only uses two MODBUS function codes:

0x03: Read-and-hold registers

0x10: Write multiple registers

MODBUS Function Code 0x03: Read-and-hold Register

This function code is used to read the continuous block content of the holding register of the remote device. Request the PDU to specify the start register address and the number of registers. Address registers from zero. Therefore, the addressing register 1-16 is 0-15. The register data in the response information is packaged in two bytes per register. For each register, the first byte contains high bits and the second byte contains low bits.

Request

Function code	1 byte	0x03
Start Address	2 byte	0x0000...0xffff
Read register number	2 byte	1...125

**Figure 8: Read-and-hold register request frame**

Response

Function code	1 byte	0x03
number of bytes	1 byte	N×2
Register values	N×2 byte	

N = Register number

**Figure 9: Read-and-hold register response frame**

The following illustrates the request frame and response frame with the read and hold register 108-110 as an example. (The contents of register 108 are read-only, with two byte values of 0X022B, and the contents of register 109-110 are 0X0000 and 0X0064)

Request Frame		Response Frame	
Number Systems	(Hexadecimal)	Number Systems	(Hexadecimal)
Function code	0x03	Function code	0x03
Start address (high byte)	0x00	Byte count	0x06
Start address (low byte)	0x6B	Register Value (High Bytes) (108)	0x02
Number of Read Registers (High Bytes)	0x00	Register Value (Low Bytes)(108)	0x2B
Number of Read Registers (Low Bytes)	0x03	Register Value (High Bytes) (109)	0x00
		Register Value (Low Bytes) (109)	0x00
		Register Value (High Bytes)(110)	0x00
		Register Value (Low Bytes) (110)	0x64

**Figure 10: Examples of read and hold register request and response frames**

## MODBUS function code 0x10: write multiple registers

This function code is used to write continuous registers to remote devices (1... 123 registers) block that specifies the value of the registers written in the request data frame. Data is packaged in two bytes per register. Response frame return function code, start address and number of registers written.

Request

Function code	1 byte	0x10
Start Address	2 byte	2 byte
Number of input registers	2 byte	2 byte
number of bytes	1 byte	1 byte
Register values	N×2 byte	N×2 byte

N = Register number

**Figure 11: Write multiple register request frames**

Response

Function code	1 byte	0x10
Start Address	2 byte	0x0000...0xffff
Register number	2 byte	1...123(0x7B)

N = Register number

**Figure 12: write multiple register response frames**

The request frame and response frame are illustrated below in two registers that write the values 0x000A and 0x0102 to the start address of 2.

Request Frame	(Hexadecimal)	Response Frame	(Hexadecimal)
Number Systems	0x10	Number Systems	0x10
Function code	0x00	Function code	0x00
Start address (high byte)	0x01	Start address (high byte)	0x01
Start address (low byte)	0x00	Start address (low byte)	0x00
Input register number (high bytes)	0x02	Input register number (high bytes)	0x02
Input register number (low bytes)	0x04	Input register number (low bytes)	
number of bytes	0x00		
Register value (high byte)	0x0A		
Register value (low byte)	0x01		
Register value (high byte)	0x02		
Register value (low byte)			

**Figure 13: Examples of writing multiple register request and response frames**

# Data format in instrument

## Overview

### Floating Point

Definition: Floating point, conforming to IEEE 754 (single precision)

Description	Symbol	Index	Mantissa	SUM
Bit	3	30...23	22...0	22...0
Index Deviation	127			

**Figure 14: floating point single-precision definition (4 bytes, 2 MODBUS registers)**

Example: Compile decimal 17.625 to binary

Step 1: Converting 17.625 in decimal form to a floating-point number in binary form, first finding the binary representation of the integer part

$$17_{\text{decimal}} = 16 + 1 = 1 \times 2^4 + 0 \times 2^3 + 0 \times 2^2 + 0 \times 2^1 + 1 \times 2^0$$

The binary representation of integer part 17 is 10001B

then the binary representation of decimal part is obtained

$$0.625 = 0.5 + 0.125 = 1 \times 2^{-1} + 0 \times 2^{-2} + 1 \times 2^{-3}$$

The binary representation of decimal part 0.625 is 0.101B.

So the binary floating point number of 17.625 in decimal form is 10001.101B

Step 2: Shift to find the exponent.

Move 10001.101B to the left until there is only one decimal point, resulting in 1.0001101B, and  $10001.101B = 1.0001101B \times 2^4$ . So the exponential part is 4, plus 127, it becomes 131, and its binary representation is 10000011B.

Step 3: Calculate the tail number

After removing 1 before the decimal point of 1.0001101B, the final number is 0001101B (because before the decimal point must be 1, so IEEE stipulates that only the decimal point behind can be recorded). For the important explanation of 23-bit mantissa, the first (i.e. hidden bit) is not compiled. Hidden bits are bits on the left side of the separator, which are usually set to 1 and suppressed.

Step 4: Symbol bit definition

The sign bit of positive number is 0, and the sign bit of negative number is 1, so the sign bit of 17.625 is 0.

Step 5: Convert to floating point number

1 bit symbol + 8 bit index + 23-bit mantissa

0 10000011 00011010000000000000000B (the hexadecimal system is shown as 0x418d0000)

Reference code:

1. If the compiler used by the user has a library function that implements this function, the library function can be called directly, for example, using C language, then you can directly call the C library function memcpy to obtain an integer representation of the floating-point storage format in memory.

For example: float floatdata; // converted floating point number

```
void* outdata; memcpy(outdata,&floatdata,4);
```

Suppose floatdata = 17.625

If it is a small-end storage mode, after executing the above statement, the data stored in the address unit outdata is 0x00.

Outdata + 1 stores data as 0x00

address unit (outdata + 2) stores data as 0x8D

address unit (outdata + 3) stores data as 0x41

If it is large-end storage mode, after executing the above statement, the data stored in outdata of address unit is 0x41  
 Outdata + 1 stores data as 0x8D  
 address unit (outdata + 2) stores data as 0x00  
 address unit (outdata + 3) stores data as 0x00

2. If the compiler used by the user does not implement the library function of this function, the following functions can be used to achieve this function:

```
void memcpy(void *dest,void *src,int n)
{
char *pd = (char *)dest; char *ps = (char *)src;
for(int i=0;i<n;i++) *pd++ = *ps++;
}
```

And then make a call to the above memcpy(outdata,&floatdata,4);

Example: Compile binary floating-point number 0100 0010 0111 1011 0110 0110 0110 10B to decimal number

Step 1: Divide the binary floating-point number 0100 0010 0111 1011 0110 0110 0110 10B into symbol bit, exponential bit and mantissa bit.

0 10000100 11110110110011001100110B

1-bit sign + 8-bit index + 23-bit tail sign bit S: 0 denotes positive number

$$\begin{aligned} \text{Index position E: } 10000100B &= 1 \times 2^7 + 0 \times 2^6 + 0 \times 2^5 + 0 \times 2^4 + 0 \times 2^3 + 1 \times 2^2 + 0 \times 2^1 + 0 \times 2^0 \\ &= 128 + 0 + 0 + 0 + 0 + 4 + 0 + 0 = 132 \end{aligned}$$

Mantissa bits M: 11110110110011001100110B = 8087142

Step 2: Calculate the decimal number

$$\begin{aligned} D &= (-1) \times (1.0 + M/2^{23}) \times 2^{-127} \\ &= (-1)^0 \times (1.0 + 8087142/2^{23}) \times 2^{132-127} \\ &= 1 \times 1.964062452316284 \times 32 \\ &= 62.85 \end{aligned}$$

Reference Code:

```
float floatTOdecimal(long int byte0, long int byte1, long int byte2, long int byte3)
{ long int realbyte0,realbyte1,realbyte2,realbyte3; char S;
long int E,M;

float D;
realbyte0 = byte3; realbyte1 = byte2; realbyte2 = byte1; realbyte3 = byte0;

if((realbyte0&0x80)==0)
{ S = 0;//positive number }
else { S = 1;//negative number }
E = ((realbyte0<<1)|(realbyte1&0x80)>>7)-127;
M = ((realbyte1&0x7f)<<16) | (realbyte2<<8) | realbyte3;
D = pow(-1,S)*(1.0 + M/pow(2,23))* pow(2,E);

return D; }
```

Function description: parameters byte0, byte1, byte2, byte3 represent 4 bytes of binary floating point number (

The decimal number converted from the return value

For example, the user sends the command to get the temperature value and dissolved oxygen value to the probe. The 4 bytes representing the temperature value in the received response frame are 0x00, 0x00, 0x8d and 0x41. Then the user can get the decimal number of the corresponding temperature value through the following call statement.

That is temperature = 17.625.

```
float temperature = floatTOdecimal( 0x00, 0x00, 0x8d, 0x41)
```

## Read instruction mode

The communication protocol adopts MODBUS (RTU) protocol. The content and address of the communication can be changed according to the needs of customers.

The default configuration is network address 01, baud rate 9600, even check, one stop bit, users can set their own changes;

Function code 0x04: This function enables the host to obtain real-time measurements from slaves, which are specified as single-precision floating-point type (i.e. occupying two consecutive register addresses), and to mark the corresponding parameters with different register addresses.

Communication address is as follows:

0000-0001: Temperature value

0002-0003: Main Measured Value

0004-0005: Temperature and Voltage Value

0006-0007: Main Voltage Value

Communication examples:

Examples of function code 04 instructions:

Communication address = 1, temperature = 20.0, ion value = 10.0, temperature voltage = 100.0, ion voltage = 200.0

Host Send: 01 04 00 00 08 F1 CC

Slave Response: 01 04 10 00 41 A0 00 41 20 00 42 C8 00 43 48 81 E

Note:

[01] Represents the instrument communication address;

[04] Represents function code 04;

[10] represents 10H (16) byte data;

[00 00 00 41 A0] = 20.0; / temperature value

[00 00 41 20] = 10.0; // Main Measured Value

[00 00 42 C8] = 100.0; // Temperature and Voltage Value

[00 00 43 48] = 200.0; // Main measured voltage value

[81 E8] represents CRC16 check code;

## pH buffer & Temperature value

Temp (°C)	pH4.01	pH6.86	pH9.18	pH4.00	pH7.00	pH10.01
0	4.01	6.98	9.47	4.01	7.12	10.32
5	4.01	6.95	9.38	4.00	7.09	10.25
10	4.00	6.92	9.32	4.00	7.06	10.18
15	4.00	6.90	9.27	4.00	7.04	10.12
20	4.00	6.88	9.22	4.00	7.02	10.06
25	4.01	6.86	9.18	4.00	7.00	10.01
30	4.01	6.85	9.14	4.01	6.99	9.97
35	4.02	6.84	9.10	4.02	6.98	9.93
40	4.03	6.84	9.07	4.03	6.97	9.89
45	4.04	6.83	9.04	4.04	6.97	9.86
50	4.06	6.83	9.01	4.06	6.97	9.83
55	4.08	6.83	8.99	4.07	6.97	9.81
60	4.10	6.84	8.96	4.09	6.98	9.79
70	4.12	6.85	8.92	4.12	6.99	9.76
80	4.16	6.86	8.89	4.16	7.00	9.74
90	4.20	6.88	8.85	4.20	7.02	9.73

## Daily maintenance

According to the requirements of use, the installation position and working condition of the instrument are relatively complex. In order to make the instrument work normally, maintenance personnel need to carry out regular maintenance on the instrument. Please pay attention to the following matters during maintenance:

1. Please check whether the installation box of the instrument is leaking or not when it is installed outdoors;
2. Check the working environment of the instrument. If the temperature exceeds the rated range of the instrument, please take appropriate measures; otherwise, the instrument may be damaged or its service life may be reduced;
3. When cleaning the plastic shell of the instrument, please use a soft cloth and a soft cleaner to clean the shell. Be careful not to let moisture enter the inside of the instrument.
4. Check whether display data of the instrument is normal or not.
5. Check whether the wiring on the terminal of the instrument is firm. Pay attention to disconnect the AC power before removing the wiring cover.

## Package Set

Product Description	Quantity
1) T6555 Online Residual Chlorine Meter	1
2) Instrument Installation Accessories	1
3) Operating Manual	1
4) Qualification Certificate	1

Note: Please check the complete set of instruments before use.  
The company's other series of analytical instruments, please login to our website for enquiries.



## Warranty

We Instruments warrants this product to be free from significant deviations in material and workmanship for a period of one year from the date of purchase. If repair is necessary and has not been the result of abuse or misuse within the warranty period, please return to We Instruments and amendment will be made without any charge. We Instruments Customer Service Center will determine if product problem is due to deviations or customer abuse. Out of warranty products will be repaired on a charge basis.

Authorization must be obtained from We Instruments Customer Service Center to issue a RIR number before returning items for any reason. When applying for authorization, please include date requiring the reason of return. Instruments must be carefully packed to prevent damage in shipment and insured against possible damage or loss. We Instruments will not be responsible for any damage resulting from careless or insufficient packing.

Warning: Damage as a result of inadequate packaging is the User / distributor's responsibility.

Please follow the guidelines below before transporting.

Use the original packaging material if possible, when transporting back the unit for repair. Otherwise wrap it with bubble pack and use a corrugated box for better protection. Include a brief description of any faults suspected for the convenience of Customer Service Center, if possible. If there are any questions, feel free to contact our Customer Service Center or distributors.

## Notes

Distinguished users, please pay attention to the following points when using the instrument, in order to ensure the life and accuracy of the instrument.

- ★ Careful handling to avoid collision and falling instruments in use.
- ★ Avoid contact with water or other liquids during use.
- ★ Don't put the instrument in the sunshine for a long time. After use, it should be stored in a cool, dry and ventilated place.
- ★ If you don't use the instrument for a long time, you should unplug the power supply to avoid accidents.
- ★ This instrument is not suitable for use in harsh environment, high temperature, low temperature or strong magnetic field interference, which may lead to instrument damage.
- ★ If there is any problem with the instrument, please contact the dealer or the company. Do not disassemble the instrument by yourself. If disassembled, the company will no longer be responsible for the warranty.





## 上海淳业仪表科技有限公司

Shanghai Chunye Instrument Technology Co.,Ltd

Tel: 021-61621082

Fax: 021-61621099

Web: [www.twinno.net](http://www.twinno.net)

Add: Building 6, No.166 Mindong Road, Pudong  
New District, Shanghai, China Post code:201209

---